

GENERAL DOOR & BUILDERS HARDWARE

ENTRANCE DOOR CLOSERS

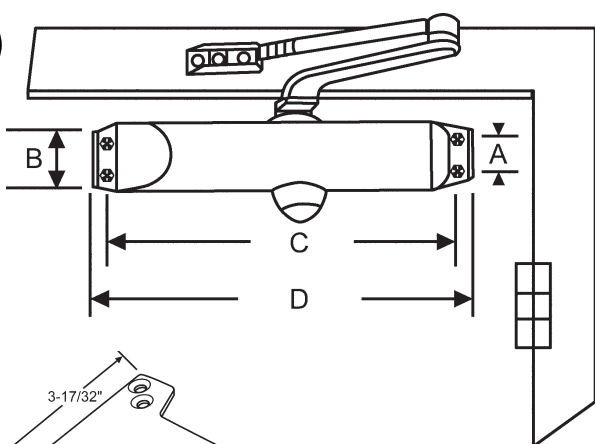

FEATURES

- Surface mounted interior and exterior
- Size 3 is used on 3 ft. wide interior door or 2-1/2 ft. wide exterior door.
- Size 4 is used on 4 ft. wide interior door or 3 ft. wide exterior door.
- Non-handed
- Permanent lubricating hydraulic fluid
- Easy, smooth action
- Housing made of non-corroding aluminum.
- Narrow design is perfect for aluminum, glass, wood and other modern doors.

Part #	Size	A	B	C	D	Finish
18-70	#3	3/4"	1-3/4"	8-3/16"	8-15/16"	Aluminum (Silver)
18-72	#3	3/4"	1-3/4"	8-3/16"	8-15/16"	Bronze (Gold)
18-74	#3	3/4"	1-3/4"	8-3/16"	8-15/16"	Duranodic (Dk. Brown)
18-68	#4	3/4"	1-3/4"	9-1/16"	9-13/16"	Aluminum (Silver)
18-69	#4	3/4"	1-3/4"	9-1/16"	9-13/16"	Bronze (Gold)
18-73	#4	3/4"	1-3/4"	9-1/16"	9-13/16"	Duranodic (Dk. Brown)

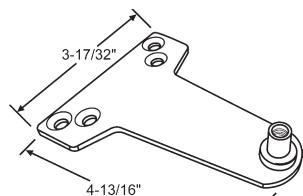

19-210
Parallel Bracket

Dimensions for Closers with Backcheck Feature

Part #	Size	A	B	C	D	Finish
18-70BC	#3	3/4"	1-3/4"	8-3/16"	8-15/16"	Aluminum (Silver)
18-68BC	#4	3/4"	1-3/4"	9-1/16"	9-13/16"	Aluminum (Silver)

POWER ADJUSTABLE CLOSER WITH BACK CHECK OR DELAYED ACTION

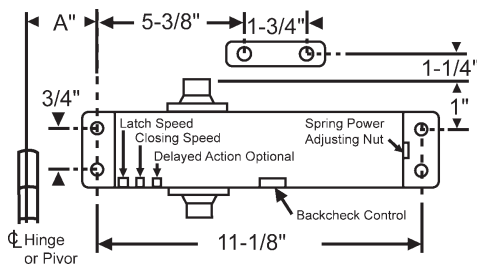
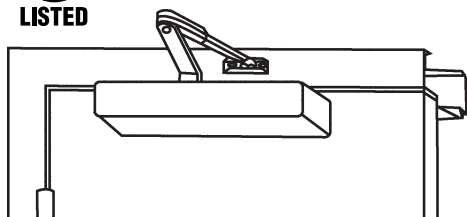

Opening	Dim. "A"
To 120°	7-3/32"
120° - 180°	3-15/16"

Part #	Finish
18-88	Aluminum (Silver)

**ANSI GRADE 1
A - 156.4 STANDARDS
APPLICABLE**

DOOR STOPS AND BUMPERS

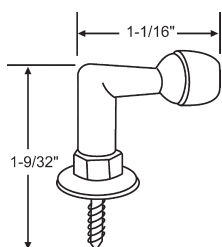

Part #	Finish
900-12356	Brass

Floor Type Door Stop

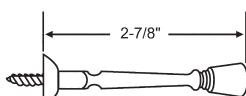

Part #	Finish
19-144	Brass

Solid Stop Bumper Assembly

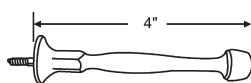

Part #	Finish
19-157	Brass
19-157DC	Dull Chrome

Solid Stop Bumper Assembly

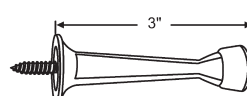

Part #	Finish
19-284SN	Satin Nickel

Solid Type

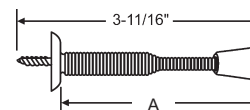

Part #	Finish	A
19-143	Brass	3"
19-143SN	Satin Nickel	3"
19-143CH	Chrome	3"
19-143-4	Brass	4"

Door Stop Bumper Assembly

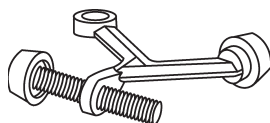

Part #	Finish
19-142	Brass
19-142A	Aluminum
19-142CH	Chrome
19-142W	White
19-142SN	Satin Nickel

Hinge Pin Door Stop

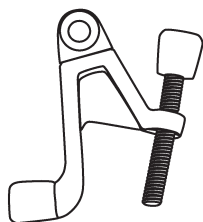

Part #	Finish
19-359	Bright Brass

Hinge Pin Door Stop



Part #	Finish	A
19-204	Brass	3"
19-204C	Chrome	3"
19-360CH	Chrome	3-3/4"

Heavy Duty Door Stop Bumper Flexible



Part #	Color
19-145	White

Hinge Pin Door Stop Bumper Only. Fits 19-142, 19-142A, 19-142CH, 19-142W



Part #	Color
19-146	White

Door Stop Bumper Only. For 9/32" OD Door Stop

DOOR STOPS AND BUMPERS

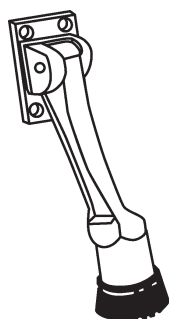

Part #	Finish
19-133	Brass
19-132	Aluminum

4" Drop Down Door Stop

Part #	Finish
19-136	Brass
19-137	Aluminum

5" Drop Down Door Stop
Solid Cast Brass

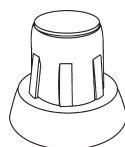

Part #	Color
19-187	Black

Rubber Tip Replacement Only.
For Drop Down Door Stops. Fits
19-132, 19-133, 19-136, 19-137

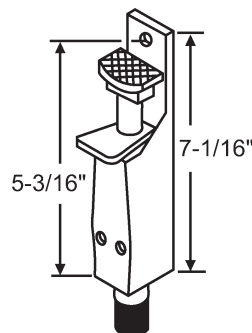

Part #	Finish
19-135	Brass
19-138	Aluminum
19-135PB	Bright Brass

19-135T

Screw type tip only.
Black

DOOR SILENCER

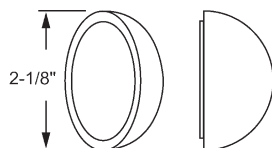

Part #	Color
19-242	White

Adhesive PVC Wall Bumper

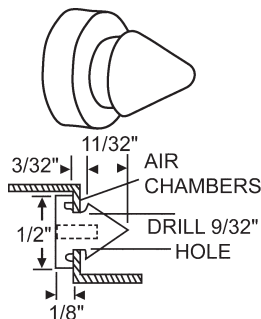

Part #	Color
19-134	Gray

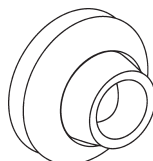

Part #	Finish
19-140	Stainless Brushed
19-140BZ	Dark Bronze
19-140AB	Antique Brass
19-140B	Brass

Screw mount, 2-1/2" diameter
with gray vinyl bumper, concealed
screw mount. Concave face to fit
interior lock button. Furnished with
anchor and screw.

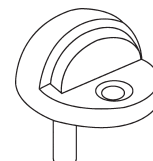

Part #	Finish
19-141	Brushed Satin

Zinc Die Cast, Low Profile
Door Stop. 1-3/4" Base, 1"
Height, 1/8" Clearance.

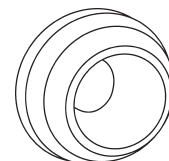

Part #	Color
19-139W	White
19-139	Gray

Adhesive backed, 1-7/8"
diameter, gray rubber, peel-off
label, pressure sensitive backed.

WALL PROTECTORS

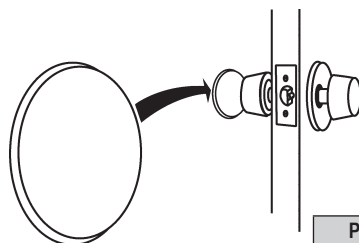

3" Diameter

Part #	Color
19-181	White
19-181OW	Off White

5" Diameter

Part #	Color
19-182	White

Made of high impact material
that can be painted or papered.
Use to repair larger areas of
wall damage. Foam adhesive
on back absorbs shock. 1/4"
Total thickness. Washable.

DOOR LOCK CHANNELS

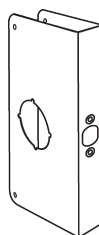

Part Number	Backset	Door Thickness
19-160-4	2-3/8"	1-3/8"

2-1/8" Bores. Large Single Hole.
Brass Plated Aluminum.
Overall Dimension 4" x 9"

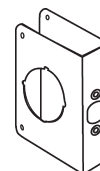

Part Number	Backset	Door Thickness
19-174-4	2-3/8"	1-3/8"

2-1/8" Bores. Small Single Hole.
Brass Plated Aluminum.
Overall Dimension 4" x 4-1/2"

DOOR KNOCKER



900-12213

Polished Brass. Name plate card.
Cast knocker with polished brass
finish. Surface mount application
Space for door viewer.
Viewer sold separately

CHAIN LOCK

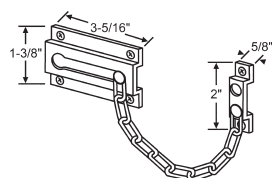

900-7490

Heavy Duty Brass Plated
Steel Door Chain with Solid
Brass Keeper



900-8108

Brass Plated Stamped Steel
Door Chain

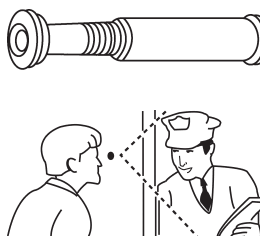

19-149

160° Angle Plastic Lens
1/2" Installation Hole. Fits doors
1-1/8" to 2-1/4" thick. Solid Brass

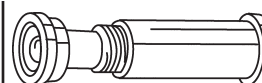

900-12562

160° angle plastic lens
fits doors 1-3/8" to 2-1/4" thick
1/2" installation hole, wide angle.
See who is on the other side
before you open the door.
Solid brass construction

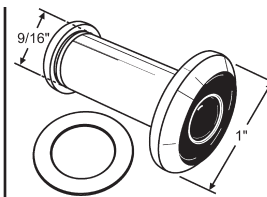

Part #	Color	Angle
19-215	Polished Brass	180°
19-215CP	Bright Chrome	180°
19-184	Polished Brass	200°

Solid Brass. 9/16" Bore, Fits
1-3/8" to 2-1/4" Thick Doors